

TEST DATA

ITEM	SPEC	SAMPLE									
		1	2	3	4	5	6	7	8	9	10
Primary Exciting Current Input 120VAC, 60 Hz	50 mA max	24	23	27							
Primary Load Current Input 120VAC, 60 Hz	75 mA max	64	65	65							
Secondary No Load DC Voltage	19V ±5%	18.94	18.98	19							
Secondary DC Voltage Load 300 mA	12V ±5%	12.07	12.04	12.1							
Secondary Voltage Load mA	V ± %										
Secondary Voltage Load mA	V ± %										
Secondary Voltage Load mA	V ± %										
Secondary Voltage Load mA	V ± %										
Ripple Voltage Load 300 mA (PK-PK)	2V max	1.2	2	2							
Hi-Pot Test 3 mA for 3Sec.	Pri. to Sec.	2K VAC	OK	OK	OK						
	Pri. to Core	2K VAC	OK	OK	OK						
	Sec. to Core	1.5K VAC	OK	OK	OK						
Temperature Rise: 70°C MAX measured By Resistance Method (Primary Winding)											
Core Film: SPLIT						Core : EI-35					
Testing Circuit: Output Plug Drawing: PLUG: 5.5X2.1mm											
<div style="display: flex; justify-content: space-between;"> <div style="width: 60%;"> <p style="text-align: center;">1000uF/25V</p>  </div> <div style="width: 35%; text-align: center;">  </div> </div>											
Output conductor length: 6 ft min (AWG#24)											
Input conductor length: ft min (AWG#)											
(V) Characteristic Curve											
											

AC Adaptor Specifications

Internal Construction Drawing and Parts List (Unit: Set or EA)

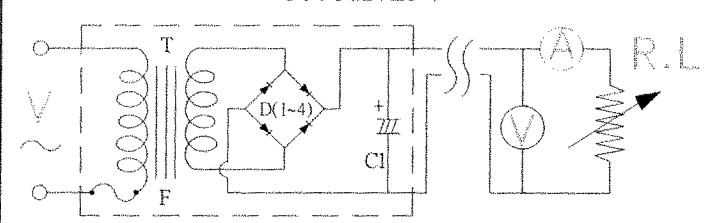
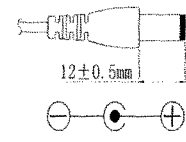
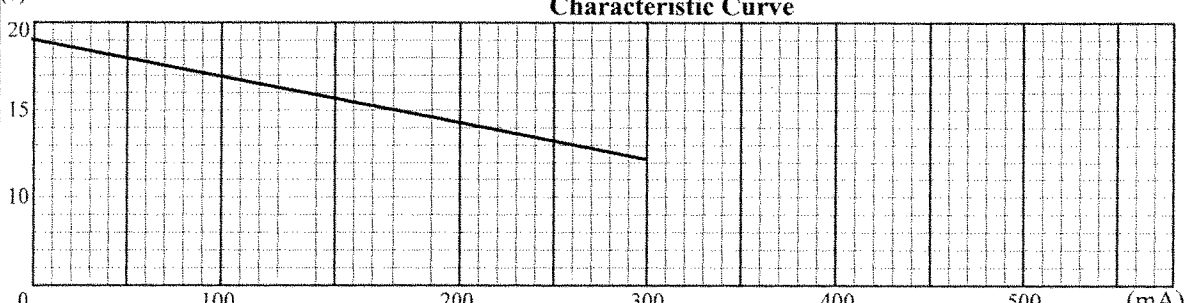
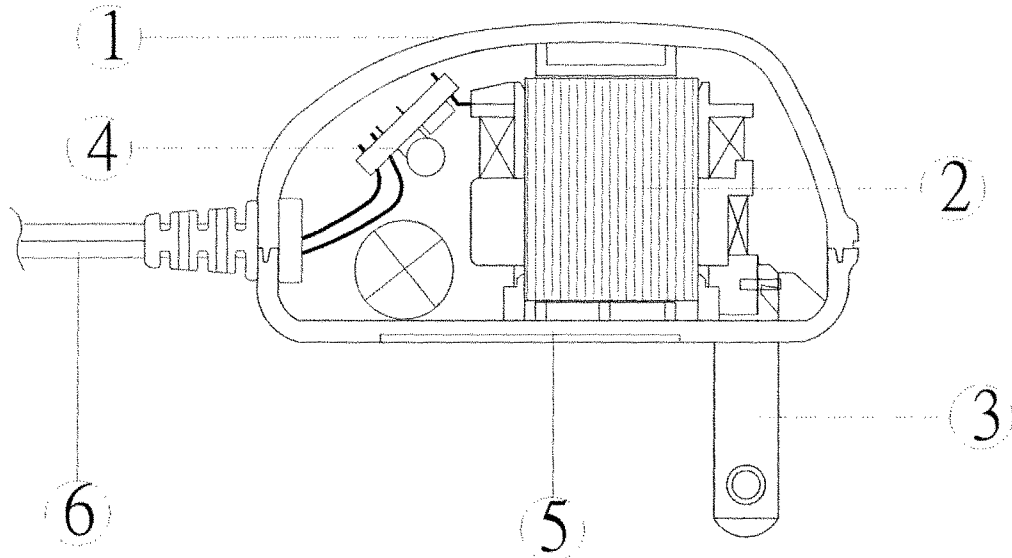

Part Name	Specification	Q'ty
1. Enclosure	Noryl SE1 94V-0 105°C	
	Noryl SE-100 94V-0 95°C	
	Noryl PX1700 94V-0 95°C	
	940(f1) 94V-0 130°C	
2. Transformer	EI-35	1
3. Blade	Ni plated brass	2
4. Print Wiring Board Assembly		
Print Wiring Board	04V0 94V-0 130°C	1
	11 94V-0 105°C	
	13 94V-0 130°C	
	BF-3 94V-0 130°C	
Diode	1A 400-700V IN4004-IN4007	4
Capacitor	1000uf 25V 85°C	1
5. Name Plate	Polyester Film	1
6. Output Cord	AWG# 24 6FT min	1



DC Adaptor Specifications

Construction Drawing and Details of Transformer

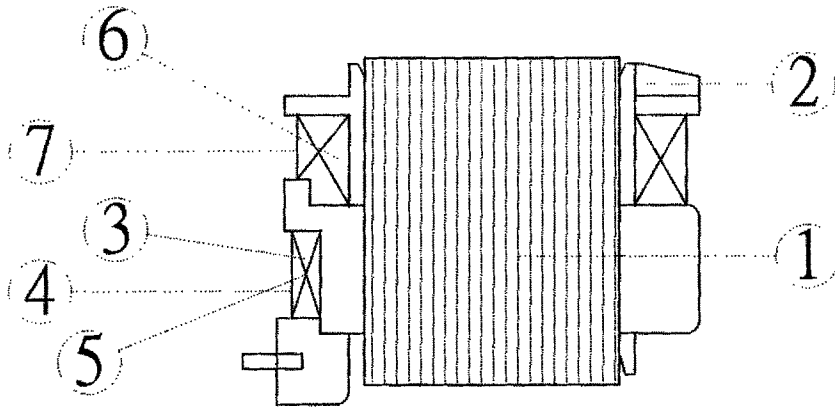

Part Name	Material & Type	Spec or Q'ty
1. Core	Silicon Steel	0.5mm
2. Bobbin	Polybutylene Terephthalate	0.71mm
	1403G6	
	PETP(QMFZ2)	
	FR-530, FR530L	
3. Primary Winding	Polyurethane Enameled	mm turn ohm
	Copper wire	
4. Primary Outer Winding	Mylar Tape	0.025mmx2T
5. Thermal Fuse	A3 125°C 2A 250VAC	1PCS
	K3 125°C 2A 250VAC	
	M30 125°C 2A 250VAC	
6. Secondary Winding	Polyurethane Enameled Copper Wire	mm turn ohm
7. Secondary Outer Winding	Mylar Tape	0.025mmx2T

DC Adaptor Specifications

Circuit Diagram

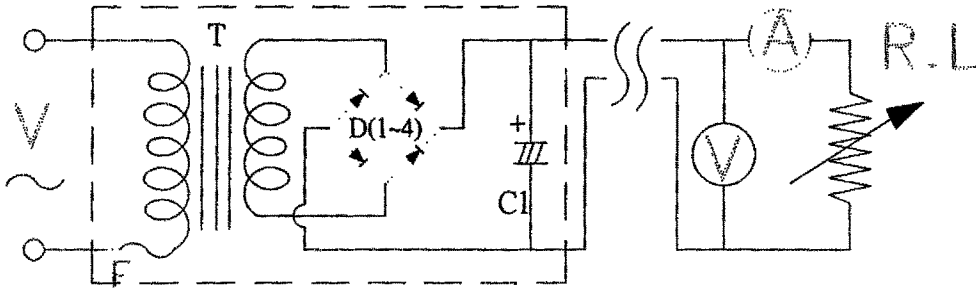

Symbol	Part Name	Note
T	Transformer	EI-35
D(1~4)	Diode	1A 400-700V IN4004-IN4007
F	Thermal	125°C 2A 250V
C1	Capacitor	1000uF 25V 85°C

AC Adaptor Specifications

Appearance Drawing (Unit:mm)

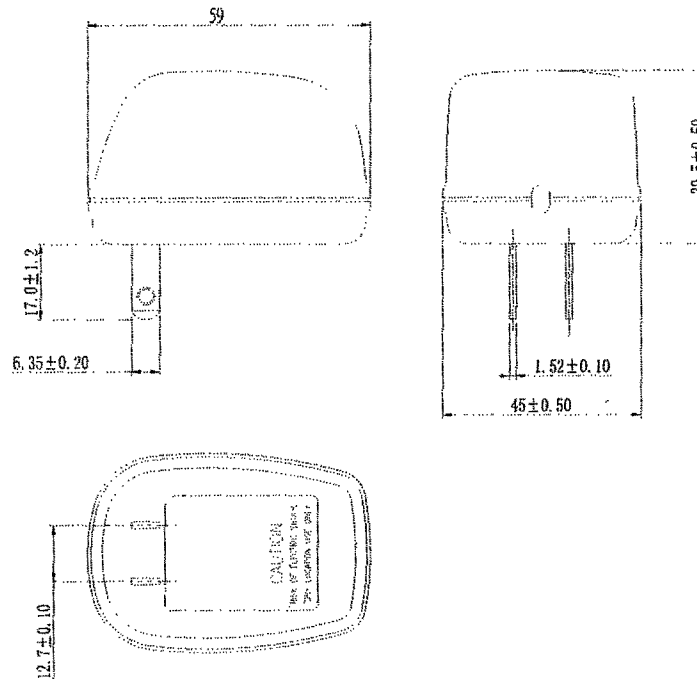

DC Adaptor Specifications

Dimension of Nameplate (Unit:mm)

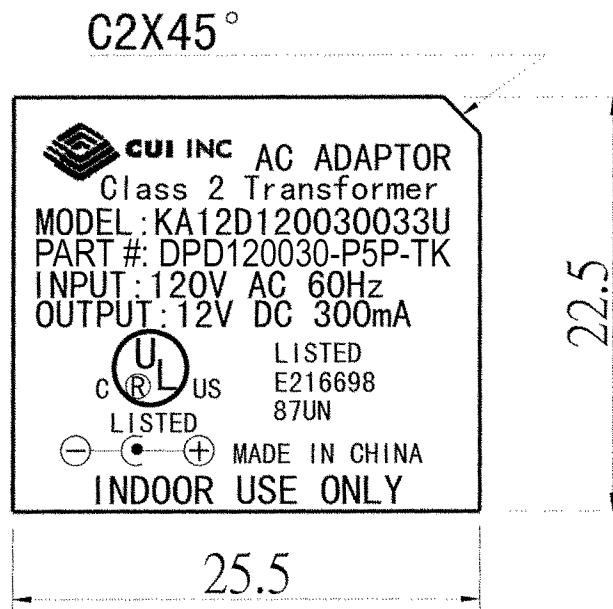

Material: Polyester Film

T: 0.25mm